

箱型U字側溝 断面図

単位：mm

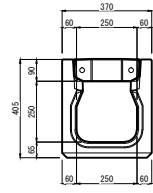

250×250

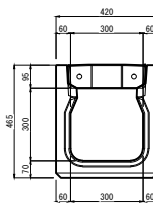

300×300

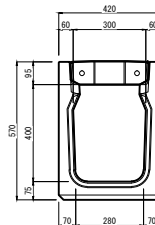

300×400

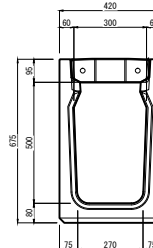

300×500

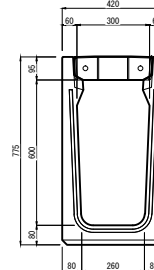

300×600

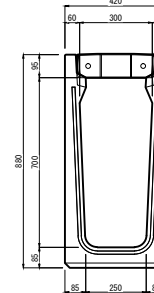

300×700

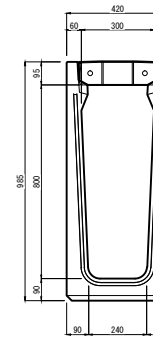

300×800



300×900

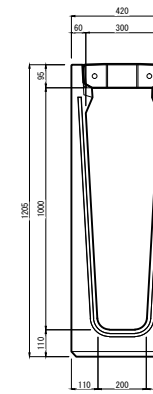

300×1000

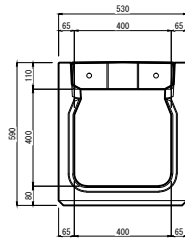

400×400

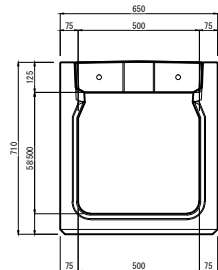

500×500

製品名	箱型U字側溝 断面図	製 図	2015. 10. 28	 東洋コンクリート工業株式会社
規 格	250・300・400・500 (T-25縦断)	図面番号		
参考質量		縮 尺	1/30	

箱型U字側溝 集水樹 断面図

単位：mm

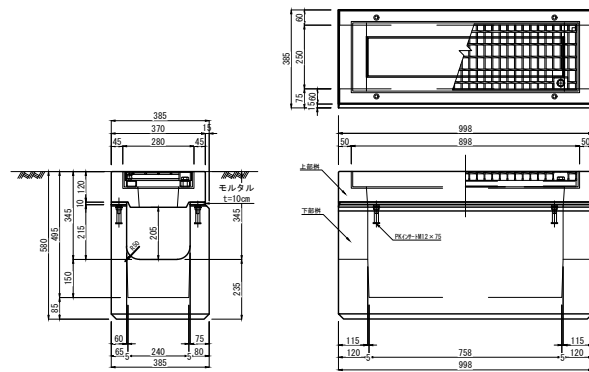

250 × 250

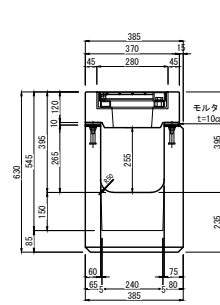

250 × 300

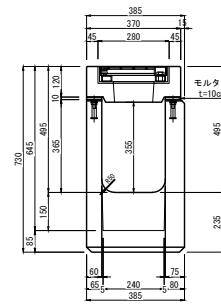

250 × 400

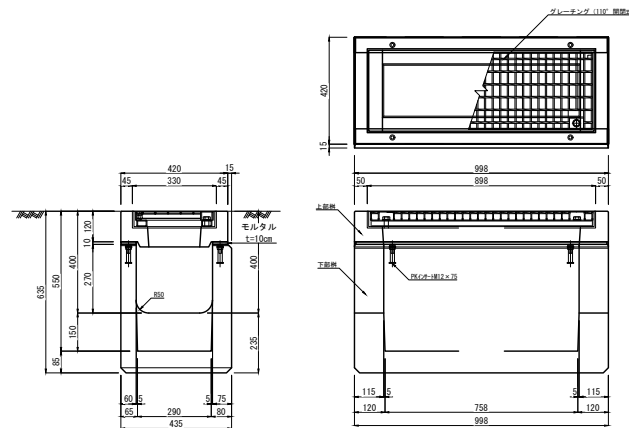

300 × 300

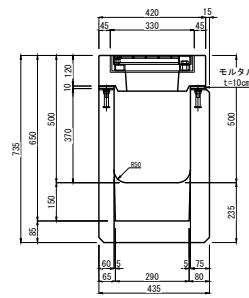

300 × 400

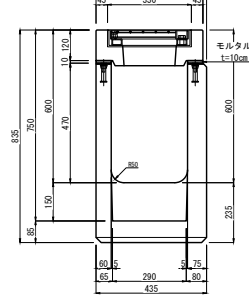

300 × 500

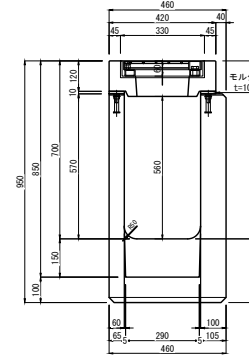

300 × 600

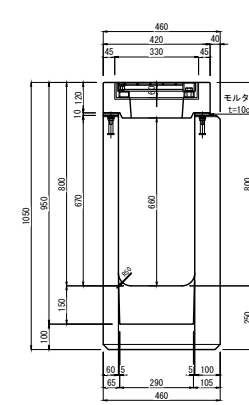

300 × 700

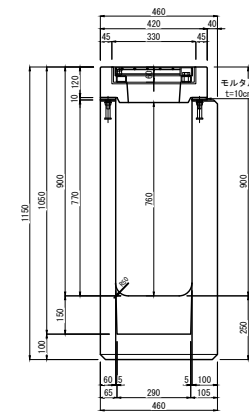

300 × 800

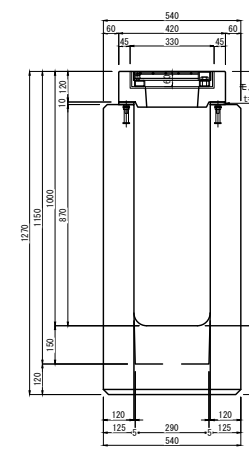

300 × 900

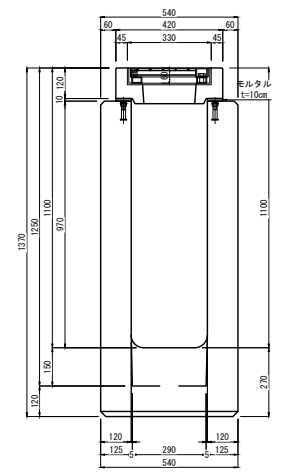

300 × 1000

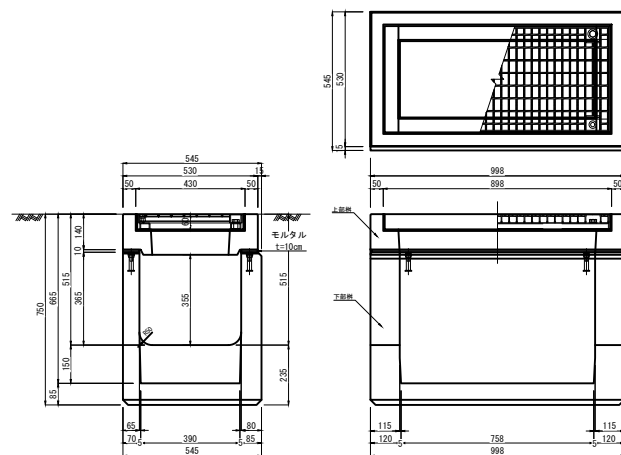

400 × 400

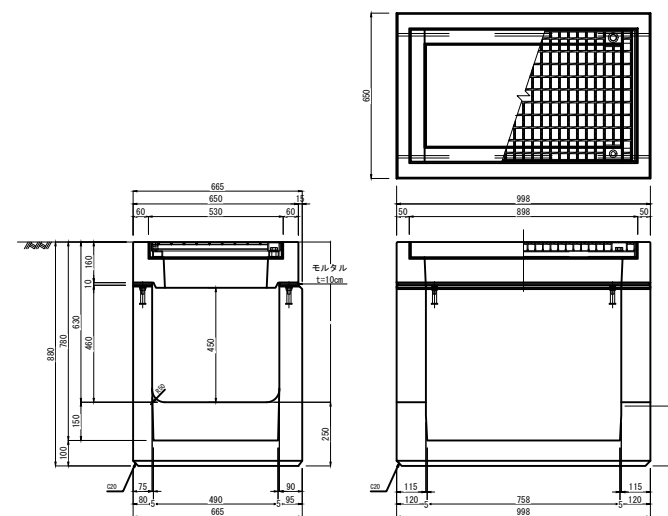

500 × 500

製品名	箱型U字側溝 集水樹 断面図	製 図	2015. 10. 28	 東洋コンクリート工業株式会社
規 格	250・300・400・500 (T-25縦断)	図面番号		
参考質量	縮 尺	1/30	設 計	